

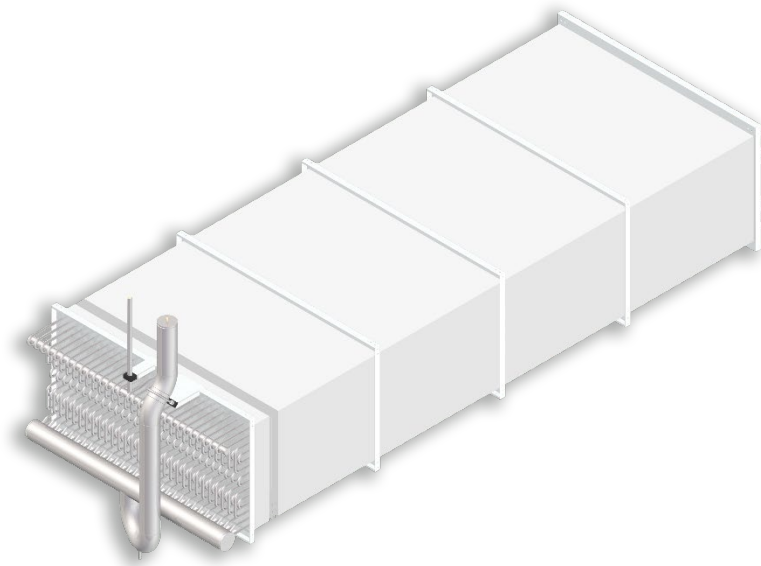

Installation manual

Heat exchanger coils



	Installation manual	15.02.2021 – Version 1.1
	Heat exchanger coils	Page: 2/32

Copyright © 2021 by thermofin GmbH, Heinsdorfergrund, Germany.

This publication is protected by copyright.

All rights reserved. All content, photos, text and graphics are protected by copyright. They may not be copied, changed, reproduced or published in whole or in part without prior written approval.

Original version

This manual has been created in several languages. The German version is a manual in the original version. All other languages are translations of the original version.

Disclaimer of liability

If problems arise in connection with the installation and/or operation of the device that are not described in this manual, the operator/installer is obliged to contact thermofin® immediately. Further installation and/or operation of the device is not permitted until the facts have been fully clarified.

The company thermofin® cannot accept any liability for damage resulting from non-observance of above-mentioned provisions. Furthermore, thermofin® reserves the right to reject any further warranty claims on this device that can be traced back hereto.

If you have further questions, please contact the company thermofin GmbH.

Contact details:

Address: thermofin GmbH
Am Windrad 1
08468 Heinsdorfergrund
Germany

Phone: +49 3765 3800-0
Telefax: +49 3765 3800-8038
E-Mail: info@thermofin.de
Website: www.thermofin.de

1.	Fundamentals	5
1.1	Safety instructions and their meaning in this installation manual	5
1.2	Warning signs and their meaning in this installation manual.....	5
1.3	Prohibition signs and their meaning in this installation manual Range of application	6
1.4	Mandatory signs and their meaning in this installation manual.....	6
1.5	General preliminary remarks.....	7
1.6	Validity	8
1.7	Scope of application	8
1.8	Standards and directives.....	9
1.8.1	Applicable documents.....	9
2.	Technical data	10
2.1	Design data.....	10
2.2	Application and intended use	10
2.3	Material data	10
2.4	Unit key.....	11
2.5	Data on the type plate.....	11
3.	Safety	12
3.1	General safety instructions	12
3.2	Safety instructions on the installation site.....	12
3.3	Safety instructions on the unit.....	13
3.4	Safety instructions on the operating supplies.....	14
3.4.1	Refrigerants of the group A1, fluid group 2	14
3.4.2	Flammable refrigerants of safety groups A2, A2L, A3	15
3.4.3	Carbon dioxide (CO ₂)	16
3.4.4	Ammonia (NH ₃)	17
3.4.5	Ethylene glycol	18
3.4.6	Water.....	19
4.	Transport, storage, positioning, installation	20
4.1	General	20
4.2	Transport.....	20
4.2.1	Packing	21
4.3	Storage	22
4.4	Lifting and positioning.....	22
4.5	Installation.....	23

 thermofin [®] heat exchangers · Germany	Installation manual	15.02.2021 – Version 1.1
	Heat exchanger coils	Page: 4/32

4.6	Piping connection	24
5.	Commissioning, normal operation, maintenance, spare parts, decommissioning, disposal	25
5.1	Commissioning	25
5.1.1	Return to service after a longer period of standstill	25
5.2	Normal operation	25
5.2.1	Defrosting	26
5.2.2	Recommendations for the positioning of the defrost sensor.....	26
5.2.3	Further information on defrosting	27
5.3	Maintenance	27
5.3.1	Cleaning of the fins	27
5.4	Spare parts	28
5.5	Decommissioning	28
5.6	Disposal	28
6.	Inspection and maintenance	29
6.1	Maintenance plan	30
7.	Troubleshooting	32

 thermofin® heat exchangers · Germany	Installation manual	15.02.2021 – Version 1.1
	Heat exchanger coils	Page: 5/32

1. FUNDAMENTALS

1.1 Safety instructions and their meaning in this installation manual

DANGER

Dangerous situation which can certainly result in serious injury or death if not avoided.

WARNING

Dangerous situation that could result in serious injury or death if not avoided.

CAUTION

Dangerous situation that could result in a minor to moderate injury if not avoided.

NOTE

Note of possible property damage

1.2 Warning signs and their meaning in this installation manual

The warning signs used are based on the DIN EN ISO 7010 standard.



W001 General warning sign



W002 Warning of explosive substances



W010 Warning of low temperature / cold



W012 Warning of electrical voltage



W016 Warning of toxic substances

	Installation manual	15.02.2021 – Version 1.1
	Heat exchanger coils	Page: 6/32



W017 Warning of hot surface



W021 Warning of flammable substances



W022 Warning of cut injuries



W023 Warning of corrosive substances

1.3 Prohibition signs and their meaning in this installation manual Range of application

The prohibition signs used are based on the DIN EN ISO 7010 standard.



P003 No open flame; fire, open source of ignition and smoking prohibited: No ignition source may be introduced or brought into the vicinity and no ignition source may arise.



P002 Smoking prohibited



P024 Entering the area prohibited

1.4 Mandatory signs and their meaning in this installation manual

The prohibition signs used are based on the DIN EN ISO 7010



M009 Use hand protection: The hand protection used must be suitable for the equipment used and for the prevailing operating temperatures.



M017 Use respiratory protection: The respiratory protective device used must be suitable for the equipment used.



M013 Use face protection: Use face protection hood.



M010 Use protective clothing: The protective clothing must be suitable for the equipment used and for the prevailing operating temperatures.



M021 Disconnect before maintenance or repair: Before starting work, switch off the electrical power supply and secure it against being switched on again. Check that there is no voltage.

 thermofin® heat exchangers · Germany	Installation manual	15.02.2021 – Version 1.1
	Heat exchanger coils	Page: 7/32

1.5 General preliminary remarks

NOTE

This manual includes the installation manual in accordance with the Machinery Directive 2006/42/EC and the operating manual in accordance with the Pressure Equipment Directive 2014/68/EU.

Operating and installation manuals serve the purpose of avoiding possible hazards to people and the environment that may arise from a device and work in connection with this device, in particular during transport, installation, commissioning and operation of the device. For this reason it is necessary to carefully read and observe all points in this manual.

⇒ A claim to warranty does not exist in the case of faults and damage that can be attributed to the fact that the specifications of this installation manual were not adhered to or in the case of complaints that arose from the replacement of parts with non-original parts or from conversions or changes not expressly authorized by the manufacturer or changes to the operating parameters or functionality of the device.

⇒ Please keep this manual in such a way that this is always accessible to all persons who have anything to do with this device. Make sure that this manual is read and understood by everyone who works with this device.

⇒ This manual is available on our website in the download area under the service section and can be downloaded as a PDF document.

Direct link: <https://www.thermofin.de/technische-dokumentation.php>

Or scan this QR code with your smartphone:



 thermofin [®] heat exchangers · Germany	Installation manual	15.02.2021 – Version 1.1
	Heat exchanger coils	Page: 8/32

1.6 Validity

The present operating and installation manual refers to heat exchanger coils of the following type series:

→ **(TB)-A, -B, -C, G, -H, -N, -S, -Q: exact designation according to data sheet**

- with or without defrosting unit.

The corresponding technical data can be seen from the current catalogue, the unit data sheet and the type plate.



For fans and electrical equipment components, the information on their identification plates and their operating manual apply primarily.

1.7 Scope of application

thermofin[®] heat exchanger coils are designed and manufactured according to customers' requirements and are intended for the installation into heat exchanger systems on site. The design and the materials used are specified for the respective case of application. The application limits with regard to pressure and temperature stated on the nameplate must be observed

Intended use includes observing this operating manual and the other applicable documents where possible, e.g. the technical documentation of the certified electrical devices (motor, terminal box).

The unit is intended for installation in a cooling or refrigeration system.

WARNING



The maximum pressure indicated on the type plate must neither be exceeded during operation nor during transport or storage or standstill!

	Installation manual	15.02.2021 – Version 1.1
	Heat exchanger coils	Page: 9/32

1.8 Standards and directives

The manufacturer certifies the compliance with the standards according to the order-related declaration of incorporation and/or declaration of conformity included in the documents of the devices.

In addition, the content of the relevant regulations and national provisions that apply at the installation site must be observed. These include, among other things, regulations on the expertise of the operating personnel, operational safety, emission protection and maintenance and repair.

A suitably qualified specialist is required for the activities described in this operating manual. This applies above all to work in the following areas:

- product selection, project planning and modification
- assembly / disassembly of the device
- installation
- commissioning
- overhaul, repairs, cleaning

Skilled workers who carry out these activities must have a level of knowledge that meets the following requirements:

- all national standards and regulations

thermofin® recommends a level of knowledge that is described in the following standards:

- EN IEC 60079-14 (project planning, selection and construction of electrical systems)
- EN IEC 60079-17 (testing and maintenance of electrical systems)
- EN IEC 60079-19 (equipment repair, overhaul and regeneration)

Local and national peculiarities and/or regulations must be taken into account.

1.8.1 Applicable documents

- the manual given here which is the part of the operating manual for the entire system provided by the system installer
- order-related designs, data sheets
- order-related or device-specific drawings
- order-related or device-specific circuit diagrams
- connection diagrams in the terminal boxes of the electrical components
- identification labels on the device

 thermofin [®] heat exchangers · Germany	Installation manual	15.02.2021 – Version 1.1
	Heat exchanger coils	Page: 10/32

2. TECHNICAL DATA

2.1 Design data





The design data of the unit are shown in the respective order documents and/or the unit data sheet. It can also be requested from factory by indicating the project or serial number (see type plate).

Only original accessories and spare parts from thermofin company may be used. Changes to the design conditions, environmental conditions, operating parameters or operating fluids must be authorized in writing by the manufacturer, otherwise the warranty claim expires.

2.2 Application and intended use

The unit as incomplete machine according to Machinery Directive 2006/42/EC is intended for the installation in cooling systems.

WARNING

-  Despite meeting the requirements of intended use and handling the unit properly, residual risks cannot be completely prevented.
-  The unit may only be put into operation when the conformity of the entire system has been established!
-  The unit may only be used in places where the materials applied are not affected by the surrounding atmosphere or the medium flowing inside.
-  Any case of application differing from the one described above requires consultation with the manufacturer.

 The manufacturer does not assume liability for any damages resulting from the non-compliance with these provisions.

2.3 Material data

Tubes: made of copper, steel or stainless steel, hard soldered or welded

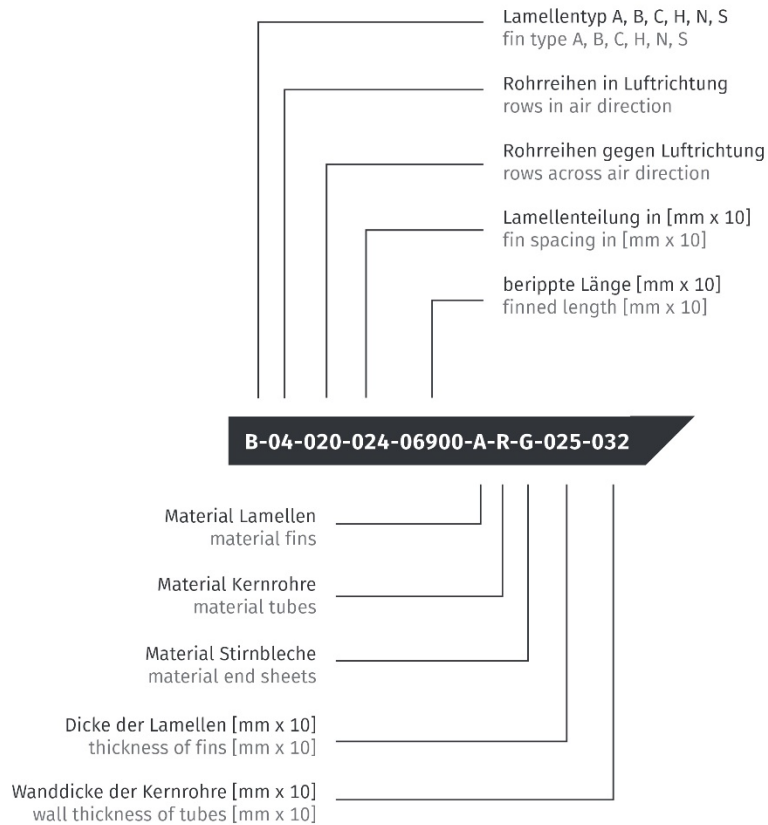

Fins: made of AlMg, aluminium with or without coating, steel, stainless steel or copper

2.4 Unit key



2.5 Data on the type plate

1. model description according to the unit key (see 2.4 unit key)
2. article number of the manufacturer
3. project or serial number
4. month / year of manufacture
5. tube volume of the coil
6. test overpressure PT
7. empty weight of the coil
8. unit number
9. maximum working pressure PS
10. allowed temperature range of the medium TS
11. pressure test medium of the coil

thermofin GmbH Am Windrad 1 DE-08468 Heinsdorfergrund			
1 Bezeichnung model/modèle	<input type="text"/>		
2 Artikel-Nr. article-no./no.d'article	<input type="text"/>	7 Leergewicht empty weight/poids	<input type="text"/> kg
3 Projekt-Nr. project-no./no. de projet	<input type="text"/>	8 Geräte-Nr. unit-no./no.d'appareil	<input type="text"/>
4 Fertigungsjahr prod. year/année de fabr.	<input type="text"/>	9 Betriebsdruck max. working pressure max./pression max.	PS <input type="text"/> bar
5 Rohrvolumen tube volume/volume tubul.	<input type="text"/> L	10 Mediumtemp. medium temp./plage de temp. d'utilis.	TS <input type="text"/> °C
6 Prüfüberdruck test pressure/pression d'épreuve	PT <input type="text"/> bar	11 Prüfmedium test medium/ fluide d'épreuve	<input type="text"/>

 thermofin® heat exchangers · Germany	Installation manual	15.02.2021 – Version 1.1
	Heat exchanger coils	Page: 12/32

3. SAFETY

3.1 General safety instructions

The unit is state-of-the-art and reliable in operation. The unit may only be used in accordance with the specifications in the catalogue and the data given on the type plate. The unit may only be installed, commissioned and maintained by competent personnel. During installation, the conditions in accordance with all applicable and valid standards and regulations must be observed. The company installing the system has to ensure the observance of all pressure and temperature limit values given on the type plate.



Compliance with the instructions of this operating manual does not release the plant operator from the obligation to install an appropriate warning system indicating each kind of malfunction immediately. In addition, emergency measures must be planned and prepared in order to prevent consequential damages in case of malfunctions.

3.2 Safety instructions on the installation site

Pipes and fittings must be protected against misuse. Emergency facilities, such as lighting, venting, escape routes and the marking of which must be provided.

The unit must be lockable in case of leakage. Devices which are used for the discharge of released refrigerants must be operable from a safe location.

Refrigerant detectors and alarm systems which warn of hazardous concentrations have to comply with applicable regulations.



No smoking at the installation site. Open fire is prohibited.

There must be sufficient free space around the unit in order to prevent dangers to the unit and its connections and to ensure smooth execution of maintenance and repair work on the unit as well as on all fittings and components.

Any electrical heating rods that may be present must be able to be pulled out completely.

The unit must be connected to the supporting structure with all fastening points evenly, without twisting or bending, and must be fastened to the supporting structure using suitable means. It must be ensured that the subsoil and supporting structure can withstand the unit load over the long term and that there are no signs of distortion or settlement.

3.3 Safety instructions on the unit

 **WARNING**

Before performing installation, repair and maintenance works, the power supply must be interrupted at all circuits. An unauthorized and / or unintentional (automatic) restart must be prevented. Zero potential must be checked and - if applicable - ensured by the means of earthing or short circuiting. Adjacent energized parts need to be covered.



Do not touch the fin edges – risk of cuts!



Beware of hot gas and hot brine lines and electrical heating elements - risk of burns!



Any unauthorized reconstructions or modifications affecting the functions or the safety of the heat exchanger are prohibited!



Any external forces acting on the equipment are to be avoided. In particular, equipment connections and manifolds may not be stressed (e.g. do not step on them).



Never use connectors, metal sheets and attachments (fans) for lifting.



Before performing welding and soldering work, the unit must be depressurized! In the event that refrigerants escape, use your personal protective equipment. Avoid any contact with the refrigerant. In case of eye contact, seek medical advice immediately!

If the temperature difference between the ambient temperature and the medium inlet temperature exceeds 70K, the **max. permitted temperature slew rate** must be observed:



Start temperature	Temperature increase max.
$T_{\text{ambient}} < +10^{\circ}\text{C}$	1.5 K/min
$T_{\text{ambient}} \geq +10^{\circ}\text{C}$	3.0 K/min

 thermofin® heat exchangers - Germany	Installation manual	15.02.2021 – Version 1.1
	Heat exchanger coils	Page: 14/32

3.4 Safety instructions on the operating supplies

3.4.1 Refrigerants of the group A1, fluid group 2

The used refrigerants R134a, R404A, R507, R407C ... are so-called safety refrigerants of the group A1 according to classification of DIN EN 378 or fluid group 2 according to 2014/68/EU, which are neither combustible nor toxic.

However, refrigerants of the group A1 are generally heavier than air and thus they may reach lower spaces. At ground level, the concentration may increase in quiescent air. In case of high concentrations, there is a risk of suffocation due to the reduced oxygen percentage in the breathable air as well as the risk of cardiac arrhythmias.

WARNING



Avoid the contact of the refrigerant with open flames or hot surfaces. Be careful when executing soldering and welding works!

The operating supplies must be prevented from escaping. Refrigerants contain solved compressor oil which shall not reach the soil!



During troubleshooting, avoid eye and skin contact as well as contact with clothes. Use your personal protective equipment.



Compressor oil circulating and remaining in the tube system is combustible!

When using refrigerants listed as F-gases, the environmental protection regulations in accordance with the F-gas regulation EU517/2014 or nationally applicable regulations must be observed!

Further and more detailed information and direction for use and first aid as well as provisions resulting therefrom are to be found in the corresponding **safety data sheet**.

 thermofin® heat exchangers - Germany	Installation manual	15.02.2021 – Version 1.1
	Heat exchanger coils	Page: 15/32

3.4.2 Flammable refrigerants of safety groups A2, A2L, A3

DANGER

Flammable refrigerants such as R32 or R290 according to fluid group 1 according to PED 2014/68/EU or A2, A2L or A3 according to DIN EN 378-1:2008 require special care when handling, especially during maintenance and repair work.

Before installing the unit, the dangers related to the risk of explosion must be clarified by the operator or the installer of the system.



If the formation of an explosive atmosphere cannot be ruled out, the operator must create an explosion protection document.



Suitable fire fighting equipment must be available in sufficient amount in the installation area of the unit.



Refrigerants are mostly heavier than air and thus they may reach lower spaces. When installing the units, any existing staircases, floor drains, ventilation shafts, suction openings, etc. must therefore be taken into account.



Avoid the contact of the refrigerant with open flames or hot surfaces. Be careful when executing soldering and welding works! Do not smoke!



Beware of electrostatic charges!



Skin contact with liquid refrigerant leads to frostbite!

Refrigeration units with flammable refrigerants of groups A2, A2L and A3 must be monitored by suitable detection systems from a fill quantity > 25 kg in accordance with DIN EN 378-3!

Further and more detailed information and direction for use and first aid as well as provisions resulting therefrom are to be found in the corresponding **safety data sheet**.

 thermofin® heat exchangers - Germany	Installation manual	15.02.2021 – Version 1.1
	Heat exchanger coils	Page: 16/32

3.4.3 Carbon dioxide (CO₂)



The carbon dioxide (CO₂) corresponds to the fluid group 2 according to PED 2014/68/EU or A1 according to DIN EN 378-1:2008 and requires special safety measures.

CO₂ is a non-toxic, colour and odourless gas. These characteristics may prevent the detection of leakages. CO₂ is neither combustible nor explosive, but from a concentration of approx. 4% and longer inhalation, it already provokes unconsciousness. From a breathing air concentration of 8%, difficulty in breathing, dizziness, racing heart and further symptoms are possible.

CO₂ is a non-toxic, colour and odourless gas. These characteristics may prevent the detection of leakages!

Constant monitoring of the system tightness and the room air concentration is necessary!

CO₂ from a concentration of approx. 4% provokes difficulty in breathing!

CO₂ displaces oxygen!



Skin contact with liquefied CO₂ leads to frostbites!

In case of leakages on the unit, it has to be locked and the emergency stop switch has to be pressed, **provided that this is possible without causing dangers**. Block the area! During the elimination of the malfunction, attention shall be paid to a dangerous CO₂ concentration in the ambient air. Ensure a good ventilation of the rooms, use a respirator which is working independently of the ambient air or ensure that the concentration of the ambient air is harmless.

In case of escaping CO₂ outdoor, remain on the windward side, block the area. Try to stop the gas escape.

In case of an outlet of liquid CO₂, a strong electrostatic load is possible!



CO₂-gas is heavier than air and shall not reach deeper rooms, floors or staircases or the sewerage system.



Repair work is to be carried out on completely emptied plant components or segments only. Ensure proper ventilation.

The exposure to CO₂ requires the strict observation of the regulations and standards with regard to occupational safety. Particularly, measures according to the own safety have to be taken. This includes wearing of personal body protection according to situation:



 thermofin® heat exchangers · Germany	Installation manual	15.02.2021 – Version 1.1
	Heat exchanger coils	Page: 17/32

Further and more detailed information and direction for use and first aid as well as provisions resulting therefrom are to be found in the corresponding **safety data sheet**.

3.4.4 Ammonia (NH₃)

DANGER

The utilized refrigerant ammonia (NH₃) corresponds to the fluid group 1 according to PED 2014/68/EU or B2 according to DIN EN 378-1:2008 and requires particular safety measures. NH₃ is a toxic, pungent smelling gas. A health risk, though, only arises well above the odour threshold (warning effect of NH₃). Although NH₃ is inflammable as well as explosive, the danger of fire and explosion is relatively low due to the high ignition temperature, the narrow flammable range and the high affinity to humidity.

NH₃ causes agitation, dizziness, vomitus and cramps; with strong concentrations it also causes suffocation and pulmonary oedemas.



NH₃ has perilous to lethal effects from a concentration of 0.2 vol. %.



NH₃ has a strongly corrosive effect, especially on eyes and mucous membranes. If NH₃ reaches the eyes, those effects cannot be stopped → disorientation. Inhaled NH₃ causes an interruption of the respiratory airflow → panic.



NH₃-fluid on the skin causes frostbite and chemical burns.

NH₃ is very toxic to aquatic organisms and may under no circumstances enter drainage systems!

In case of leakages on the unit, it has to be locked and the emergency stop switch has to be pressed, **provided that this is possible without causing dangers**. During the elimination of the malfunction, attention has to be paid to residual NH₃ under boiling retardation.

NH₃-gas may not enter into neighbouring rooms, corridors or staircases.

Repair work is to be carried out on completely emptied plant components or segments only. Ensure proper ventilation. In case of works or sojourns in areas with high concentrations, use a respirator which is working independently of the ambient air!

The exposure to NH₃ requires the strict observation of the regulations and standards with regard to occupational safety. Particularly, measures according to the own safety have to be taken. This includes the wearing of safety equipment for the body according to the situation:



 thermofin® heat exchangers · Germany	Installation manual	15.02.2021 – Version 1.1
	Heat exchanger coils	Page: 18/32

Further and more detailed information and direction for use and first aid as well as provisions resulting therefrom are to be found in the corresponding **safety data sheet**.

3.4.5 Ethylene glycol

WARNING

Ethylene glycol is a colourless, slightly viscous, slightly volatile and hygroscopic liquid that can be mixed with water. It has a sweetish smell and taste. Ethylene glycol vapours are heavier than air and thus they may reach lower spaces. At ground level, the concentration may increase in quiescent air. In case of high concentrations, there is a risk of suffocation due to the reduced oxygen percentage in the breathable air.

The operating supplies must be prevented from escaping.



Ethylene glycol is combustible! When in vaporous or gaseous state, it is potentially explosive at higher temperatures!



After skin contact, ethylene glycol causes a slight irritation with the risk of skin resorption. Eye contact causes mucous membrane irritations. After being swallowed, the substance produces states of agitation with disorders of the central nervous system as well as fatigue, loss of consciousness, coordination disorders and kidney damage.



Keep ethylene glycol away from ignition sources, do not smoke!

Avoid the contact of ethylene glycol with open flames or hot surfaces. Be careful when executing soldering and welding works!



During troubleshooting, avoid eye and skin contact as well as contact with clothes. Use your personal protective equipment. Take off soiled or soaked clothes immediately!

Further and more detailed information and direction for use and first aid as well as provisions resulting therefrom are to be found in the corresponding **safety data sheet**.

 thermofin® heat exchangers - Germany	Installation manual	15.02.2021 – Version 1.1
	Heat exchanger coils	Page: 19/32

3.4.6 Water

The used operating fluid - water - is characterised by a very good specific heat emission as well as high cost-saving availability. Following instructions have to be observed when operating with water:

CAUTION

The operating supplies must be prevented from escaping.

Cooling water is no drinking water!

Cooling water may contain toxic or harmful additives (anti-corrosive agents) as well as residues or fractions of motor oil and may not contaminate soil or the sewage system.

During repair works avoid eye and skin contact as well as contact with clothes. Risk of irritations. Risk of scalding from coolant temperatures of 60°C and more. Release overpressure before opening the circuit.

	Installation manual	15.02.2021 – Version 1.1
	Heat exchanger coils	Page: 20/32

4. TRANSPORT, STORAGE, POSITIONING, INSTALLATION

4.1 General

The device may only be installed, integrated into an overall system, operated and repaired by specialist companies with appropriately competent personnel.



During production and before delivery, each unit is subjected to comprehensive quality testing. The unit is provided in good order and condition. With delivery and before assembly, the unit must be checked for damages (damages in transit).

4.2 Transport



During transport, the unit must be handled with special care. In particular, always place the unit very carefully on the ground!

If indications on transport or storage are attached to the unit or the packaging, they must be absolutely observed!



Attachment points: Attach device here



No attachment point: **DO NOT** attach here!



DO NOT use a forklift or pallet truck on this side!



Areas or components marked in this way must **NOT** be entered!

NOTE



Continuous mechanical loads due to bumps and potholes on the roadway can cause damages in transit.



Transportations by ship can cause damages in transit due to vibrations.



In case of critical transport routes (countries with bad streets or seaway) the mounting parts which could be set into vibration, especially fans, collectors, foot stands, must be disassembled and secured separately.

 thermofin [®] heat exchangers · Germany	Installation manual	15.02.2021 – Version 1.1
	Heat exchanger coils	Page: 21/32



Units must be firmly fixed on the transport vehicle and protected against vibrations, punches and slipping!

4.2.1 Packing

Decisive factors for packing are the route of transport, the size of the equipment and the regulations applicable in the country of importation.



If not otherwise expressly agreed, the delivery is effected ex works in standard transport packaging at the discretion of thermofin[®]. According to contractual agreement, design and packaging are sufficient for the transport to the contractual agreed place of transfer of risk.



The purchaser is responsible for a possible further transport and the respective packaging, unless otherwise expressly agreed.



In case of a packaging by external companies ordered by the purchaser or the customer, thermofin[®] cannot give any warranty for the design of the packaging and possible resulting transport damages. A safe design of the packaging should be agreed with thermofin[®].

The pallets, crates and export boxes used for thermofin[®] units meet the requirements of the HPE and VDM standards (HPE – German Federal Association for Wooden Packages, Pallets and Export Packaging; VDM – Association of the German Furniture Industries). If required, they can be tailored to the standards of ISPM 15.

thermofin[®] transport packages are made of environmental friendly materials and they are suitable for recycling.

According to the German regulation on packaging, we are prepared to take back our packages if they are returned to us, delivered free to our location in Heinsdorfergrund.

Usually, thermofin[®] units are provided completely assembled, with the exception of the vibration dampers which are always delivered as loose parts. In the event that a unit is delivered disassembled – due to transportation or other reasons – it must be assembled on site according to the order-specific drawings enclosed.

Loading on road vehicles is performed in accordance with the VDI guideline 2700 “Securing of loads on road vehicles”.



In case of groupage traffic and reloading, the responsibility lies with the forwarder.

 thermofin® heat exchangers - Germany	Installation manual	15.02.2021 – Version 1.1
	Heat exchanger coils	Page: 22/32

4.3 Storage

If the units must be stored, the following points must be observed:



Store the units on a proper, dry place protected against environmental influences! Protect the fans against rain and condensation humidity (cold-warm)!



Store the units in an uprising, torsion-free and deflection-free manner!



Do not open the junctions; maintain the delivery pressure of the unit!



Do not stack more than two units! Respect the suitable packing size!

4.4 Lifting and positioning

When positioning the equipment, the lifting instructions attached to the device must be observed. Furthermore, the appropriate lifting accessories must be used. The sheet metal components of the housings may not be deformed by the belts. If it is not possible to ensure sufficient rope length (angle to the perpendicular of max. 30°), a traverse must be used. The lifting accessories may only be attached to the suspension points intended for this purpose.



Never use pipes or attachment parts for lifting!



The factory-provided transport weight (empty weight of the unit + transport packaging) can be found on the corresponding label fixed to the transport packaging.



In case of using floor-borne vehicles a sufficient length of the forks must be ensured. Please pay attention to the position of the centre of gravity as well as to the signs!

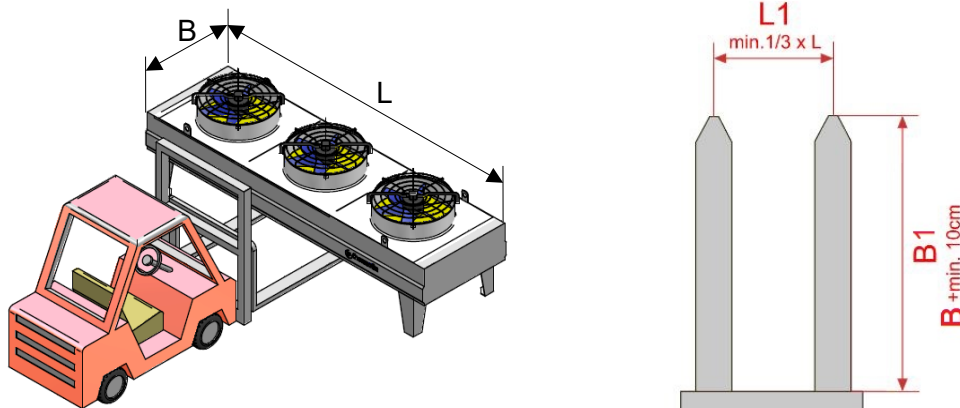

If further indications on transport or storage are attached to the unit or the packaging, they must be absolutely observed!

4.5 Installation

The suitability and the load bearing capacity of the suspension points, brackets, machine frames etc. – provided by the customer – are not the responsibility of the equipment manufacturer.

It must be ensured that the unit rests evenly on all contact points. It must be fixed on the supporting structure by using appropriate fasteners. For the bearing capacity of the construction on site as well as the dimensioning of the used screws, threaded rods or similar, the filling weight as well as a possible ice accumulation must be observed additionally to the net weight and the number of suspension points given on the type plate.

Formula for the calculation of the suspension load:

$$F_{\max} = \frac{(\text{unit empty weight} + \text{filling weight} + \text{additional weight})}{\text{Number of suspensions}} \times \text{safety coefficient}$$

The heat exchanger must be fixed in such a manner that it is not damaged or affected in its function due to environmental hazards (production processes, transports, other technical installations in proximity, etc.). Switches and blocking devices must be protected against unauthorised use.

After installation and before commissioning, all packaging parts as well as means for transport protection must be removed.

4.6 Piping connection

NOTE

Soldered or welded units or units closed with counter flanges are delivered with an overpressure of approx. 1 bar (cleaned and dried air) (according to the regulation for the transportation of hazardous material ADR 1.1.3.2 c).

Before opening the unit, it must be verified that the overpressure is present.
 A depressurized unit indicates a leakage (Damage in transit! Leak test!).

In case of depressurized units, the manufacturer must be consulted immediately.
 Before assembly, the transport pressure must be released and the closing caps must be removed.

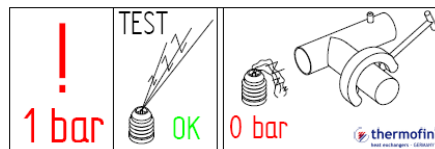

➔ Pipe connections must be designed in such a way that any force, stress and vibration effects on the unit are prevented.

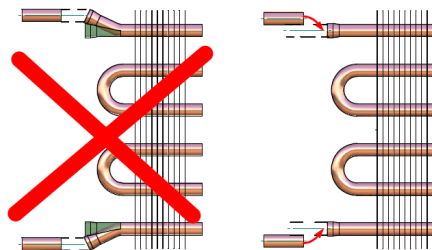

➔ In access lines, a fixed point must be provided at a distance of max. 500mm from the unit connection. Follow inlet and outlet according to the marking.

➔ Flange seals on dry coolers must not be greased, sealing surfaces must be clean, bright and even.

➔ Follow inlet and outlet according to the marking.

➔ Refrigerant distributors must be arranged vertically. Distributor capillaries must not be shortened.

 thermofin® heat exchangers - Germany	Installation manual	15.02.2021 – Version 1.1
	Heat exchanger coils	Page: 25/32

5. COMMISSIONING, NORMAL OPERATION, MAINTENANCE, SPARE PARTS, DECOMMISSIONING, DISPOSAL

5.1 Commissioning

Before and during commissioning, the unit's readiness for operation must be verified according to the following points:

1. Has the unit been properly installed and fixed in accordance with the instructions of the present manual?
2. Have all fluid-carrying lines been connected and checked for tightness? Are the shut-off devices open?
3. Is the flow direction correct?
4. Are all cables properly installed and completely connected? Has cabling been done according to the wiring diagrams provided?
5. Has the electrical protective installation been checked for proper functioning?
6. Have all bolted connections (e.g. fans, cable entries), fastenings, electrical connections etc. been checked for tight fit?
7. Are all terminal boxes and cable entries firmly closed and tight?
8. Do the fans rotate freely and in the right direction?

The following measures must be taken during commissioning:

1. Check and, if necessary, adjust the direction of rotation of the fans.
2. Measure the current consumption of the fans and check for compliance with the type plate data.
3. Adjust the electrical switching and control devices and check for correct functioning (see the specific operating manual of the respective control device).
4. Check the switch point settings of the safety equipment.

5.1.1 Return to service after a longer period of standstill

If the unit is intended to be put into operation again after being shut down and standing still for a longer period of time, the following points must be checked in addition to those mentioned under "5.1 Commissioning":

1. Visual inspection of the heat exchanger coil, check for fouling and damages
2. Leak test of the heat exchanger coil
3. Visual inspection and functional test of the fans; check for free running, check the terminal boxes for tightness, check for corrosion and noise (bearings)
4. Check all pipe connections (including pipe clips), electrical components, housings and attachment parts for tight fit

5.2 Normal operation

For running the unit, the entire plant including the electrical system must be operating. The unit is integrated in the cooling circuit by opening the corresponding shut-off valves. It is turned on by activating the electrical system.

 thermofin® heat exchangers · Germany	Installation manual	15.02.2021 – Version 1.1
	Heat exchanger coils	Page: 26/32

After reaching the system-specific operating point the unit is ready for operation.

In case of operating conditions which differ from those stated in the quotation, the manufacturer must be consulted.

5.2.1 Defrosting

In order to durably ensure the efficiency and the operational safety of the heat exchanger, it must be defrosted timely and regularly. The defrost process is started automatically via defined intervals or as required. The finalisation of the defrosting must be doubly secured (time/temperature or temperature/temperature). Usual defrost procedures are circulating air, hot gas or electro defrosting. For economic reasons, defrost procedures without electric heating rods shall be preferred. Please observe the following instructions for a proper defrosting:

- Start the defrost process timely.
- Take measures against pressure exceedance (Pump down...).
- The defrosting process must be effected completely, this means after finalisation of the defrost process ice and frost must be completely defrosted. The selection of the defrost end temperature and the position of the defrost sensor are of vital importance.
- Between end of defrosting and restart, the cooling and ventilation, a dripping time of 3 to 5 minutes is recommended. During this time, the water must be dripped completely and drained off.
- After beginning of the cooling phase, the connection of the fan shall be delayed by approx. 3 minutes. The defrost heat is received by the heat exchanger coil and is not blown through the room as warm and humid air or water drops through the fans.



Risk of burns on heating rods and hot gas lines!

5.2.2 Recommendations for the positioning of the defrost sensor

Circulation air defrosting: In case of operating the units in rooms with positive temperatures $\geq +5^{\circ}\text{C}$, defrosting with circulation air is sufficient in many cases.

→ Recommended sensor positioning: lower area of the finned coil on the air outlet side.

Hot gas defrosting: A sufficient amount of hot gas must be available in order to effect the defrost process efficiently and completely.

→ Recommended sensor positioning: In the finned coil on the hot gas outlet area on the air inlet side.

Electric defrosting: Take safety measures against overheating of the units in interior (temperature limiter) and against pressure exceedance (pump down switching) according to the prescriptions of DIN EN 378 as well as EN 60519-2 and VDE 0721. An operation without temperature safety circuit is not permitted!

 thermofin® heat exchangers - Germany	Installation manual	15.02.2021 – Version 1.1
	Heat exchanger coils	Page: 27/32

→ Recommended sensor positioning: In the upper area or on the position of the finned coil, the furthest from the next heating rod on the air inlet side.

5.2.3 Further information on defrosting

In rooms with temperatures below the freezing point, defrost water outlets and tubes must be heated in order to prevent a freezing of the condensate inside of the tube. For the same reason, the room must not be equipped with siphons. Always use provided defrost closing means (dampers...).

5.3 Maintenance

The manufacturer recommends performing particular maintenance works at regular intervals. The type and frequency of the measures strongly depend on the respective installation site of the heat exchanger.

5.3.1 Cleaning of the fins

Depending on the installation site, mode of operation and the season, the heat exchanger fins are subject to fouling (varying degree). As this directly affects the performance and thus the current consumption of the unit, the cleanliness of the finned coil must always be ensured.

⚠ WARNING

⇒ Switch off the unit (regarding refrigeration and electricity)!

Dry cleaning: with a vacuum cleaner, broom or a soft brush from the outside towards the fins or from the inside towards the outside by using compressed air – opposite to the direction of the air flow of the fans.

Wet cleaning: with a water jet from the inside towards the outside and opposite to the direction of the air flow of the fans; and from top to bottom. The jet of the cleaning device must be vertical to the heat exchanger coil (max. deviation $\pm 5^\circ$), in order to prevent fin deformations.

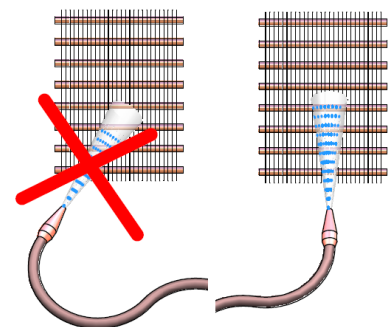

 thermofin® heat exchangers - Germany	Installation manual	15.02.2021 – Version 1.1
	Heat exchanger coils	Page: 28/32

 Use of high pressure and steam pressure washers up to 80bar max.

 Electrical components may not be exposed to the water jet!



When using cleaning agents, the compatibility of materials must be ensured. Never use aggressive or corrosive cleaning agents! In case of doubt, consult the manufacturer or supplier of cleaning agents. Application rules of the manufacturer with regard to handling and use, especially dosage, reaction time and after-treatment, must be strictly respected.



Mechanical cleaning with hard objects, such as steel brushes or screwdrivers may destroy the heat exchanger, therefore it is not permitted.

5.4 Spare parts

After-sales services shall be performed by the responsible specialist company. Spare parts are stated in the spare parts list enclosed in the annex or in the specified drawing. They can also be requested from the manufacturer by indicating the device name and the project number on the type plate. Only use original spare parts for the replacement of equipment components.

5.5 Decommissioning

The units are part of a cooling system. Unit decommissioning and return to service must meet the system-dependent requirements as well as the requirements of the operating manual of the equipment manufacturer and of the applicable standards and accident prevention regulations (see also section “1.3 Applied standards and directives”).

The decommissioning is effected by closing the fluid-bearing tubes and by switching off the electrical system.



The following applies for all units: Exceeding the maximum pressure must be prevented!

5.6 Disposal



Empty the system properly in a technically correct manner; properly dispose of the working fluid. No emissions in the environment!



Oil residuals must not reach the ground and must be disposed of with the special waste.





Bring the emptied unit to recycling.

 thermofin [®] heat exchangers · Germany	Installation manual	15.02.2021 – Version 1.1
	Heat exchanger coils	Page: 29/32

6. INSPECTION AND MAINTENANCE

NOTE

- 
 Depending on type, installation and environmental conditions, the heat exchangers are subject to different signs of wear and contamination during operation. In order to ensure an excellent operation and a maximum operational reliability, periodical maintenance measures must be executed.
- 
 Maintenance and repair measures as well as recurring inspections should comply with the valid standards and statutory provisions, e.g. EN378, 517/2014EC, VDMA 24243, 2006/42EC, 2014/68/EU, EN 60079-17 and/or local factory standards or regulations applicable at installation site.
- 
 Measures that result from the documents of the installed fans, attachment parts and electrical components must be carried out. See the operating and maintenance manuals included in the scope of supply.

The following table under point 6.1 can serve as a general recommendation.

6.1 Maintenance plan

Inspection point	Main topic	Interval	Actions
General visual inspection	General condition Corrosion Pollution	Monthly	Initiate corresponding maintenance measures
Heat exchanger coil	Pollution Tightness	Quarterly	Cleaning Repair leakage if necessary
Piping connections	Tight fit Tightness Deformations	Quarterly	Ensure tight fitting Repair leakage if necessary Determine the cause, contact manufacturer if necessary
Connections and fixations	Tight fit Tightness Deformations	Quarterly	Ensure tight fitting Repair leakage if necessary Determine the cause, contact manufacturer if necessary
Shut-off-devices, valves, security modules	Function Accessibility	Quarterly	Damaged parts to be replaced Accessibility must be ensured again
Fans, motors, impellers	Function Free running Noises Pollution	Quarterly	Remove obstacles and pollutions, Replace bearing if possible Replace damaged fans
	Closed condensate holes	Half-yearly	Open and drain condensate
Switching devices	Function Accessibility	Quarterly	Replace damaged parts Accessibility must be ensured again
Junction boxes, strain reliefs, cable fittings	Tight fit Tightness Function	Quarterly	Replace damaged parts Retighten screws Retighten loosened screw connections
Safety equipment and devices Emergency signals Alarm systems	Function	Yearly	Replace damaged parts
Pressure relief equipment	Tightness Visual inspection	Yearly	Replace damaged parts

 thermofin [®] <small>heat exchangers · Germany</small>	Installation manual	15.02.2021 – Version 1.1
	Heat exchanger coils	Page: 31/32



The measures listed are a minimum. Higher requirements resulting from maintenance plans of the operator or the specialist company commissioned with maintenance have priority.

7. TROUBLESHOOTING

Incident	Cause	Action
Drop of cooling capacity, air outlet temperature too high, air flow too low, condensation temperature too high, condensation pressure too high Medium outlet temperature too high	Coil iced	Defrost the coil
		Check automatic defrosting
		Check defrost heating
	Fins soiled Air flow too low	Cleaning the soil and/or the system-side filters
	Fan out of work	Check power supply
		Measure power consumption
Check appropriating terminal box		
Check thermostat relay		
Vibrations	Fan out of balance	Ice build-up on the fan blades
		Check impellers for damages, possibly exchange fan
Noises	Impellers and motors do not rotate freely or rub	Remove any existing (ice) obstacle
	Bearing damage on motor	Replace fan
Leakage	Damaged and leaking core tube	Locate and repair core tube, possibly giving up
	Leaking bend or connector	Repair or exchange the part



Repair work may only be carried out by qualified and authorized persons.



Before doing any repair work on the device, contact thermofin®, see last page of this manual for contact.



When replacing device parts, only use original thermofin spare parts. These can be obtained from thermofin® by stating the project number.